

Metal Woman

FUNCTIONAL ART—LOW VOLTAGE







METAL WOMAN WITH MESH BACKLIGHT
SHIELD AND EGGCRATE LOUVER ACCESSORIES
Shown approximately 45% actual size.

fa_metalwoman_spec.pdf

September 2003

TECH
Lighting[®]

Metal Woman

FreeJack	MonoRail	Two-Circuit MonoRail	Kable Lite	TwinRail	Tech trak™
N/A					

FUNCTIONAL ART

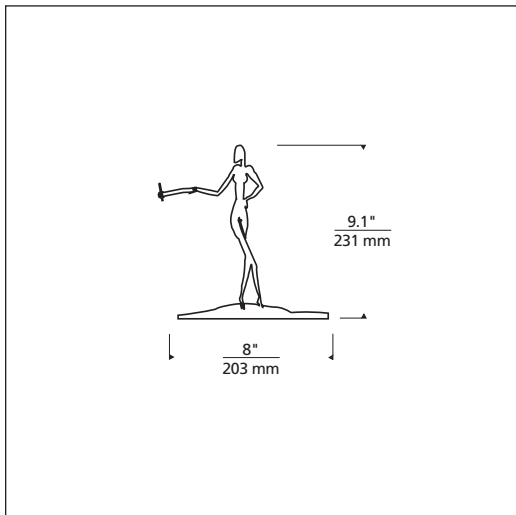
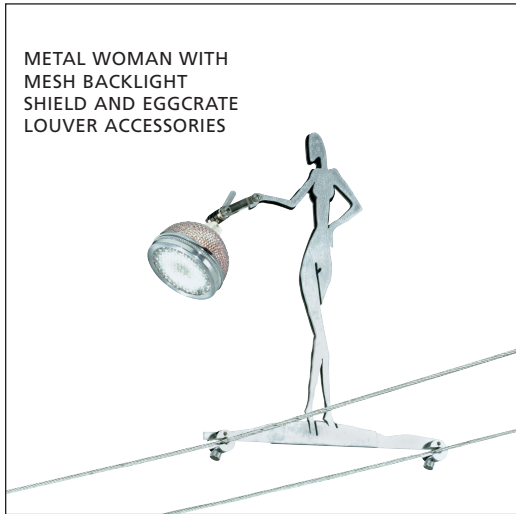

DESCRIPTION

Slinky metal woman holds positionable MR16 socket. 8" width only. System mounting bracket or Kable Lite mounting feet included.

SYSTEM

Available for MonoRail, Two-Circuit MonoRail, Kable Lite, TwinRail and Tech Trak™.

COLOR

None

FINISH

Chrome, satin nickel.

LAMP

Low-voltage, MR16 lamp of up to 75 watts (not included).

ACCESSORIES AND OPTICAL CONTROLS

Wild Thing, Sun Louver Lens Holder, Lil Wings, Flight Paper, Marble Louver, Hoop, MR16 Snout, Charlotte's Web, Round Glass Shield, Cone Glass Shield, Lil Egypt, Lil Wok, Barndoors, Snap Barndoors, Backlight Shield, Louver Lens Holder, Snap Louver Lens Holder, Eggcrate Louver, Glass Lens.

WEIGHT

0.14 lb./0.06 kg.

ORDERING INFO:

700	SYSTEM	MW	FINISH
	MO MONORAIL		C CHROME
	MO2 TWO-CIRCUIT MONORAIL		S SATIN NICKEL
	KL KABLE LITE		
	TW TWINRAIL		
	TT TECH TRAK (SATIN NICKEL ONLY)		

700 _____ MW _____

FIXTURE TYPE: _____

JOB NAME: _____



7401 North Hamlin T 847.410.4400
Skokie, Illinois 60076 F 847.410.4500

www.techlighting.com



Specifications subject to change without notice.